

TOMORROW
LAB SINCE 1945

75
YEARS

eppendorf



The Next Benchmark

Eppendorf Centrifuge 5910 R and Centrifuge 5920 R

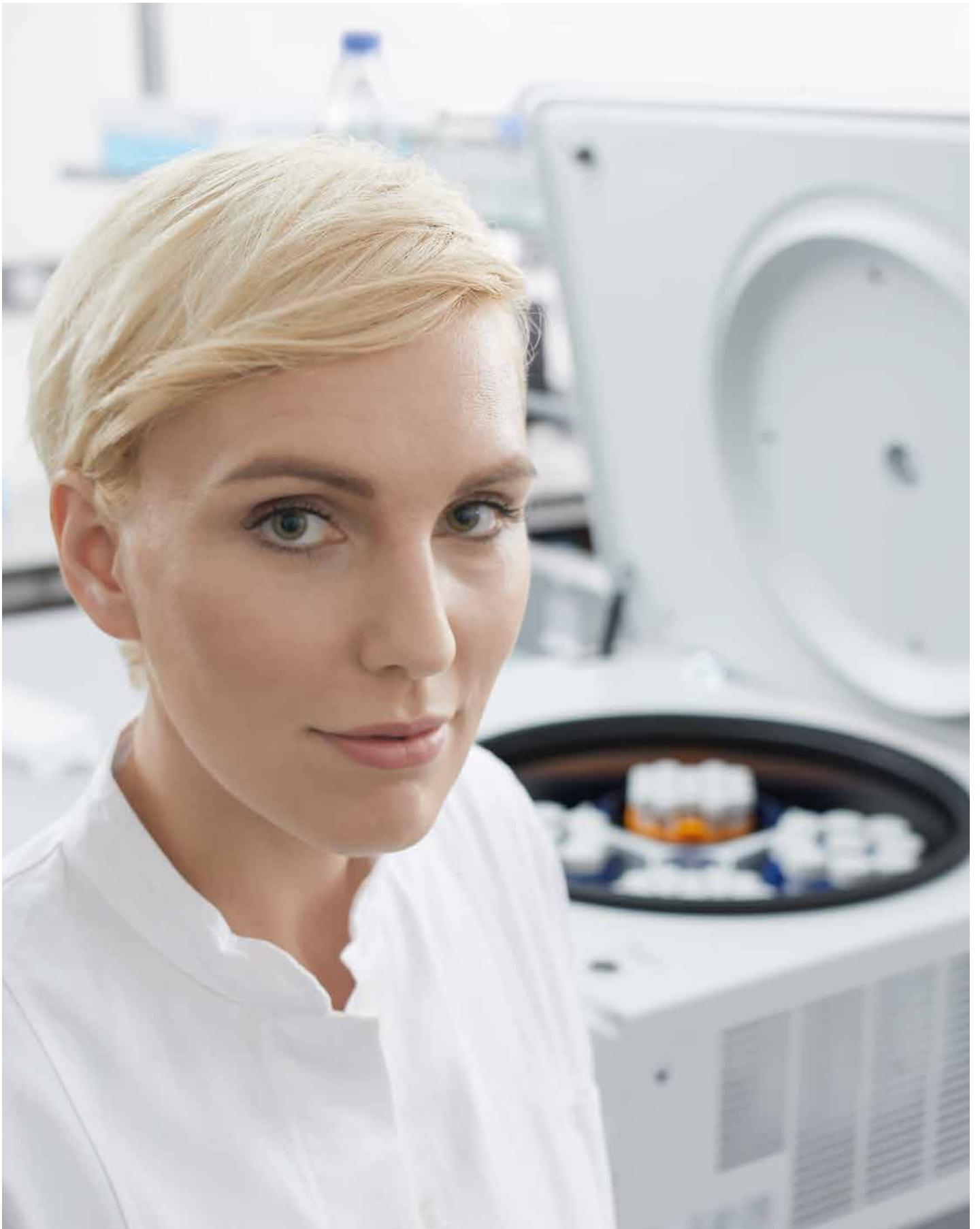

»Eppendorf – A New Spin on Centrifugation.«

Whether you choose the new Centrifuge 5910 R with great versatility or the well established Centrifuge 5920 R with more capacity, both instruments follow the same extremely high Eppendorf standards in temperature management, safety and convenience.



Advanced temperature management

Temperature management is much more than just cooling. Eppendorf offers state-of-the-art hardware and software features for energy efficiency and sample protection. We have thought of everything so that you don't have to worry about your samples.

> See page 4 for more information.



Innovative safety features

Eppendorf centrifuges have a reputation of being an essential workhorse in the lab. Operation is simple, seamless and safety comes as standard. Automatic rotor recognition and built-in imbalance sensors protect the centrifuge, your samples and most importantly – you.

> See page 5 for more information.



Excellent user convenience

The user is at the center of all our efforts and optimization measures. Centrifuge 5910 R and Centrifuge 5920 R have been engineered to be extremely quiet and handling is convenient. Eppendorf has taken all the measurements to make everyday work more enjoyable.

> See page 6 for more information.

Centrifuge 5910 R and Centrifuge 5920 R

Advanced temperature management

Eppendorf developed the Dynamic Compressor Control (DCC). Unlike other compressors which switch back and forth between 0% and 100% performance output, DCC allows for a constant and smooth temperature regulation. This results in a precise cooling performance and the set temperature is kept stable at all time.

In addition to the well-known FastTemp function for super fast pre-cooling, both instruments include the new FastTemp pro® software option. This feature allows for automated pre-cooling based on pre-programmable time and date. Simply turn the centrifuge into standby mode when you leave your lab and let FastTemp pro take care of pre-cooling in the morning so you don't have to. This saves you more than 90% of energy over night and programming is super easy.

Centrifuge 5920 R: Energy saving overnight with ECO shut-off and FastTemp pro®

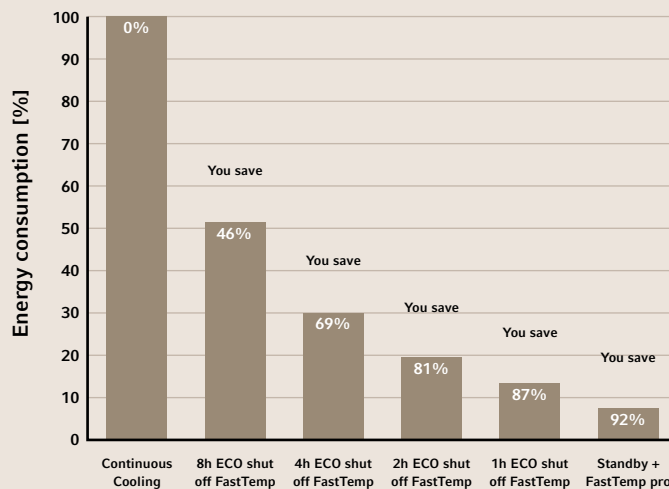

Innovative safety features

Centrifuge 5910 R and Centrifuge 5920 R have an automatic rotor recognition. This feature detects a newly inserted rotor and automatically limits the centrifuge speed to the rotor's maximum permissible value.

When handling substances that pose a health hazard it is highly recommended to use aerosol-tight fixed-angle rotors with Eppendorf QuickLock® lids or swing-bucket rotors in combination with Eppendorf QuickLock caps.



- > Automatic rotor recognition and imbalance detection for maximum operational safety
- > Sturdy motor driven lid locks to ensure secure operation
- > Not one but two gas springs to support the lid
- > Aerosol-tight rotors and buckets to avoid contamination



Centrifuge 5910 R and Centrifuge 5920 R

Excellent user convenience

For ergonomic lid operation Eppendorf designed the soft-touch lid closure system. There is no need to exert unnecessary force when closing the centrifuge lid. In combination with a low opening height you can close the centrifuge with ease.

Centrifuge 5910 R and Centrifuge 5920 R feature an advanced operation system that comes with an easy to use interface to make the operation intuitive and more enjoyable. The multilingual operation menu includes 5 program keys for easy access to your routine programs.



- > Soft-touch lid for stress-free instrument closing
- > Low access height for easy loading and unloading
- > Low noise level to improve your work environment
- > Large display and intuitive operating system
- > 5 program keys for easy access to routine programs



Feature	Centrifuge 5910 R	Centrifuge 5920 R
1,000 mL Eppendorf bottles (see pages 14–15 for more information)	4	–
1,000 mL standard bottles	–	4
750 mL bottles (see pages 14–15 for more information)	4	4
180 – 250 mL bottles (flat)	4	8
50 mL conical tubes	36	52
25 mL conical tubes	36	52
5 mL and 15 mL conical tubes	68	108
1.5/2.0 mL Eppendorf Tubes®	200	368
BD Vacutainer® CPT™ (16 mm × 125 mm/8 mL)	28	80
16 mm round-bottom and blood collection tubes	104	148
13 mm round-bottom and blood collection tubes	120	196
PCR plates/MTP	20/4	28/8
Universal adapters for conical tubes, plates and bottles	■	■
Dual use of plates and tubes in one rotor bucket	■	■
Plate rotor options for MTP, PCR or DWP	■	■
Fixed-angle rotors for high-speed applications	■	■

Centrifuge 5910 R – Great Versatility



With its great versatility, the refrigerated 4 liter Centrifuge 5910 R is setting the next benchmark for benchtop centrifuges. The universal swing-bucket rotor with unique universal adapters allows centrifugation of conical vessels up to 50 mL, plates, and 250 mL bottles for the first time without the need to change rotors, rotor buckets, or adapters. This improves handling and saves time.

Great versatility for a variety of applications

- > Swing-bucket rotors and adapters accommodate tubes and bottles from 0.2 mL to 1,000 mL
- > Plate rotor options for centrifugation of all types of MTP, PCR or deepwell plates (DWP)
- > Fixed-angle rotors for high-speed molecular biology applications in vessels from 0.2 mL to 250 mL
- > High centrifugation speed of up to $22,132 \times g$ (14,000 rpm)

Spin the Bottle

The new 400 mL and 1,000 mL centrifuge bottles are a reusable solution for large-volume, low-speed applications. The 1,000-mL bottle was specially designed for swing-bucket rotor S-4xUniversal and upgrades Centrifuge 5910 R into a 4-liter system. The 400 mL bottle fits into swing-bucket rotor S-4x400. See pages 14–15 for more information.

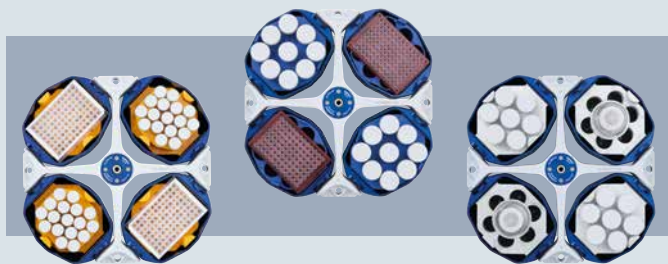

New versatile universal adapters

Three innovative universal adapters can spin a selection of tubes, bottles and plates:

- > Adapter 1: 5.0 mL and 15 mL conical tubes, DWP, MTP
 - > Adapter 2: 25 mL and 50 mL conical tubes, MTP
 - > Adapter 3: 25 mL and 50 mL conical tubes, 250 mL bottles, MTP
- See page 19 for more information.



> More information:
www.eppendorf.com/centrifuge-5910R

Centrifuge 5920 R – More Capacity



As awarded by The Chicago Athenaeum: Museum of Architecture and Design.

Refrigerated Centrifuge 5920 R delivers extraordinary high capacity in a very compact and ergonomic product design. It has similar dimensions as competing refrigerated 3 Liter models and yet features a superior capacity of up to 4 × 1,000 mL standard bottles or 52 × 50 mL conical tubes thus making it the ideal instrument for high-throughput applications.

More Capacity for higher throughput

- > Accommodates standard 1 liter Nalgene® bottles setting a new standard in the table top centrifuge segment
- > Swing-bucket rotors and adapters accommodate tubes and bottles from 0.2 mL to 1,000 mL
- > Fixed-angle rotors for high-speed molecular biology applications in tubes from 0.2 mL to 250 mL
- > Plate rotor options for centrifugation of all types of MTP, PCR or DWP
- > Three innovative universal adapters can spin a selection of tubes, bottles and plates. See page 29 for more information.



> More information:
www.eppendorf.com/centrifuge-5920R



Mobile Tables

Description

Is space a limited resource in your lab or are you looking for an ergonomic positioning of your Eppendorf centrifuge? The new Eppendorf mobile tables save precious benchtop space and provide the freedom and flexibility to use your Centrifuge 5804/5804 R, 5810/5810 R, 5910 R or 5920 R wherever you need it.

Free up your bench. Use the mobile tables if there is not enough space on the regular lab bench, or to lower operating height of your centrifuge for a more ergonomic work environment. You can also transport and use the centrifuge in other labs.



Whether you choose the low design model for under bench storage of your centrifuge or the high design model for ergonomic loading and unloading of rotors and samples, both mobile tables have a very sturdy design for safe centrifugation and are equipped with heavy-duty transport wheels and brakes. And both follow the same extremely high Eppendorf standards in safety and reliability.



Low design model

- > Fits under standard 90 cm lab bench with centrifuge lid closed
- > Saves valuable benchtop and floor space while not in use
- > Dimensions (W x D x H): approx. 75 x 70 x 39 cm



High design model

- > Lowers centrifuge to an ergonomic height for easy loading and unloading
- > Fits in any empty floor space – ideal to replace a floor-standing centrifuge
- > Dimensions (W x D x H): approx. 75 x 70 x 58.5 cm

Ordering information

Description	Order no.
Mobile table for under bench storage (low design) , fits under standard 90 cm lab bench with centrifuge lid closed, for Centrifuge 5804/5804 R, 5810/5810 R, 5910 R and 5920 R	5921 000 010*
Mobile table for ergonomic loading and unloading (high design) , fits in any empty floor space, for Centrifuge 5804/5804 R, 5810/5810 R, 5910 R and 5920 R	5921 000 012*

* Coming soon

epServices
for premium performance



Centrifuge Performance Plans

An annual inspection and maintenance of centrifuges and rotors by an Eppendorf certified service technician is highly recommended to ensure a safe working environment.

Certification Services

Installation Qualification (IQ) and Operational Qualification (OQ) services make sure that temperature accuracy, rotational speed verification and operating time meet manufacturer's specifications.

Over the years, all rotor structures will eventually suffer from fatigue due to stress of high numbers of cycles. If not maintained correctly, surface scratches can lead to microscopic and then to critical cracks. Qualified inspection will detect damages early in order to prevent further equipment failure.

■ ESSENTIAL CHECK

> Check of all fundamental functions of the product

■ ADVANCED MAINTENANCE

> Preventive maintenance service to meet manufacturer specifications

Our service includes cleaning, instructions for proper care and visual examination of rotors and adapters determining if the rotor is safe for further operation or needs to be replaced.

The Performance Plans feature

> Manufacturer-specific test procedures
> GLP supporting documentation

Value of service

> Highest degree of security in your lab
> Longer service life of the system

> Further information and local offers in your country:
www.eppendorf.com/epServices



Overview of Swing-Buckets Rotors



Model	Rotor S-4xUniversal-Large	Rotor S-4x1000 high-capacity buckets	Rotor S-4x1000 plate/tube buckets	Rotor S-4x1000 round buckets
Positioning	Extra high capacity and versatility	Extra high capacity	High capacity	Medium capacity, compatible with 1 Liter bottle
5910 R				
5920 R	■	■	■	■
Universal bucket	yes	no	no	no
Aerosol-tightness	yes	no	yes	yes
Max. capacity	4 x 750 mL	8 x 250 mL	40 x 50 mL	4 x 1,000 mL
Max. RCF	4,402 x <i>g</i>	3,153 x <i>g</i>	3,076 x <i>g</i>	3,428 x <i>g</i>
Max. speed	4,250 rpm	3,700 rpm	3,700 rpm	3,700 rpm
1.5/2.0 mL micro tube	368			200
Eppendorf Tubes® 5.0 mL and 15 mL conical	96	108	88	56
25 mL snap cap tubes	40	48	36	24
25 mL screw cap tubes	40	52	40	28
50 mL conical tubes	40	52	40	28
13 mm round-bottom and blood collection tubes	196	196	140	92
16 mm round-bottom and blood collection tubes	148	144	132	80
750 mL bottle	4			4
1,000 mL Eppendorf bottles				
1,000 mL standard bottles				4
PCR plates/MTP	20	24	40	
Deepwell plates (DWP)	8	8	8	



Rotor S-4xUniversal	Rotor S-4x750 with round buckets	Rotor S-4x500	Rotor S-4x400
High capacity and versatility	Medium capacity, high speed	Medium capacity	Medium capacity, high speed
■	■	■	■
yes	no	no	no
yes	yes	yes	yes
4 x 1,000 mL	4 x 750 mL	4 x 500 mL	4 x 400 mL
4,347 x g	4,800 x g	3,220 x g	5,263 x g
4,500 rpm	4,700 rpm	4,000 rpm	5,100 rpm
184	200	96	104
68	56	48	28
36	24	20	16
36	28	20	16
36	28	20	16
120	92	100	60
104	80	64	44
4	4		
4			
20	16	16	
4	4	4	

Bottles for Centrifuge 5910 R and Centrifuge 5920 R

Eppendorf bottles for Centrifuge 5920 R

Volume	Order no.	Size Diameter x Height	Bottom shape	Material	S-4x Universal-Large	AT*	S-4x1000 Round Bucket	AT*
400 mL, blue lid	5810 729 009	80 x 133 mm	flat	PP				
500 mL	5820 707 003	83 x 134 mm	flat	PP				
750 mL	5820 708 000	102 x 133 mm	flat	PP	■	■	■	■
400 mL, grey lid	5910 707 002	81 x 117 mm	flat	PP				
1,000 mL	5910 770 006	118 x 133.1 mm	flat	PP				

* Aerosol tight cap possible.



Eppendorf bottles for Centrifuge 5910 and Centrifuge 5920 R

S-4x750	AT*	S-4xUniversal	AT*	S-4x500	AT*	S-4x400	AT*
				■			
				■	■		
■	■	■	■				
						■	■
		■	■				



Overview of Fixed-Angle Rotors



Model	Rotor FA-6x250	Rotor FA-6x50	Rotor FA-20x5
Positioning	Processing of cells in higher volumes at high speed	Molecular biology applications in tubes up to 50 mL	Applications in Eppendorf Tubes® 5.0 mL
5910 R	■	■	■
5920 R	■	■	■
Aerosol-tightness	yes	yes	yes
Max. capacity	6 × 250 mL	6 × 50 mL	20 × 5 mL
Max. RCF	15,054 × <i>g</i>	20,130 × <i>g</i>	20,913 × <i>g</i>
Max. speed	10,100 rpm	12,100 rpm	13,100 rpm
1.5/2.0 mL micro tube		6	20
Eppendorf Tubes® 5.0 mL and 15 mL conical	24	6	20/0
25 mL conical tubes	6*1,2	6*2,3	
50 mL conical tubes	6	6	
85 mL Oak Ridge	6		
250 mL bottles	6		

*1 Screw cap tubes only

*2 Please order adapter for 25 mL conical tubes screw cap 5820 734 000.

*3 Please order adapter for 25 mL conical tubes snap cap 5820 733 004.

Advanced Rotor Design – Fixed-Angle Rotors



Low rotor weight

Eppendorf's fixed-angle rotors are among the lightest in the industry to improve handling and operational safety. Light-weight rotors cause less wear and tear on the motor and allow for faster acceleration and braking times.

Cross section of Rotor FA-6x50 (6 × 50 mL conical) showing the light-weight design. All metal not needed for safety or performance is hollowed out to reduce weight and improve handling.



Rotor FA-48x2
Aerosol-tight microcentrifuge tube rotor
■
■
yes
48 × 2 mL
21,194 × <i>g</i> (5920 R) / 22,132 × <i>g</i> (5910 R)
13,700 rpm (5920 R) / 14,000 rpm (5910 R) rpm
48

Rotor FA-30x2
Aerosol-tight microcentrifuge tube rotor for safe centrifugation of hazardous samples
■
yes
30 × 2 mL
20,984 × <i>g</i>
13,700 rpm
30

Rotor F-48x15
High-capacity fixed-angle rotor for 15 mL conical and glass tubes
■
40 × 15 mL
5,005 × <i>g</i>
5,500 rpm
0/40

Eppendorf QuickLock® lids for ergonomic lid locking
 Our aerosol-tight QuickLock rotors close with only ¼ of a turn. This not only saves you time during every day use, it also takes repetitive stress off your wrist.

Superior temperature control
 Aluminum, with its high heat conductivity, allows fast pre-cooling and accurate temperature control in refrigerated centrifuges.

Perfect fit with Eppendorf Conical Tubes 15 mL and 50 mL
 The Eppendorf Conical Tubes are characterized by an outstanding centrifugation stability of up to 19,500 × *g**4. This makes them suited for a broad range of applications.

*4 Test conditions: Rotor FA-45-6-30 in Eppendorf Centrifuge 5810 R (using a suitable centrifuge adapter for 15 mL tube), sample: Saline solution (density: 1.0 g/mL), controlled centrifugation temp.: 25 °C, centrifugation time: 90 min



Rotors for Centrifuge 5910 R



Rotor S-4xUniversal

- > High capacity swing-bucket rotor with max. speed $4,347 \times g$ (4,500 rpm)
- > Broad range of adapters enables high versatility for tubes and flasks from 0.2 mL to 1,000 mL and plates
- > Universal bucket design accommodates both plates and tubes
- > Universal adapters accommodate selective plate formats and conical tubes
- > Aerosol-tight QuickLock caps for safe centrifugation of hazardous samples optionally available^{*1,2,3}
- > Buckets, caps and adapters are autoclavable

^{*1} Aerosol-tightness tested by Public Health England, Porton Down, UK.

^{*2} Aerosol-tight caps compatible with MTP, DWP 96 500 μ L, DWP 384 200 μ L. Aerosol-tight caps not compatible with DWP 96 1,000 μ L and 2,000 μ L.

^{*3} When used with aerosol-tight caps the max. capacity is reduced to 20 x 50 mL (5 x 50 mL per adapter).

Ordering information

Description	Order no.
Rotor S-4xUniversal , incl. universal buckets	5895 200 001
Aerosol-tight caps , for Rotor S-4xUniversal, set of 2 pcs.	5910 750 005
Wide-neck bottle 750 mL , for Rotor S-4-104, S-4x750, S-4x1000, set of 2 pcs.	5820 708 000

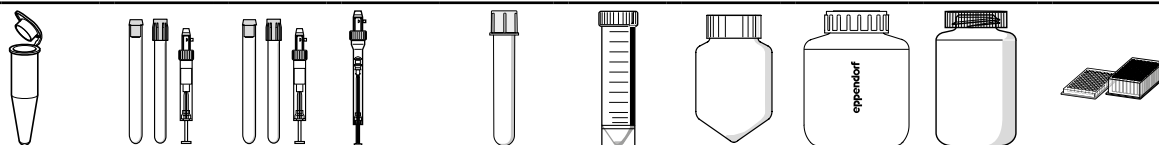

Adapters for Rotor S-4xUniversal

Tube Volume	1.5 mL/ 2.0 mL	4 mL – 8 mL	7.5 mL – 12 mL	9 mL	12 x 75 mm, 5 mL FACS	50 mL conical, skirted	500 mL Corning®	750 mL	1,000 mL	MTP, DWP, PCR plates
Max. tube diameter	11 mm	13 mm	16 mm	17.5 mm	12 mm	31 mm	96 mm	102 mm	118 mm	–
Max. vessel height	43 mm	119 mm	120 mm	120 mm	112 mm	124 mm	148 mm	139 mm	133 mm	80 mm
Max. vessel height for use with cap/lid^{**}	43 mm	117 mm	118 mm	118 mm	107	121	–	135 mm	133 mm	66 mm
Adapter										
Number of vessels per adapter/rotor	46/184	30/120	26/104	21/84	46/184	7/28	1/4	1/4	1/4	5/20 MTP 1/4 DWP
Bottom shape	flat	round	round	round	round	flat	conical	flat	flat	flat
Centrifugation radius	187 mm	190 mm	195 mm	188 mm	189 mm	185 mm	187 mm	188 mm	188 mm	170 mm
Max. RCF	$4,233 \times g$	$4,302 \times g$	$4,415 \times g$	$4,256 \times g$	$4,279 \times g$	$4,188 \times g$	$4,234 \times g$	$4,256 \times g$	$4,256 \times g$	$3,849 \times g$
Packing	set of 2 pcs.	set of 2 pcs.	set of 2 pcs.	set of 2 pcs.	set of 2 pcs.	set of 2 pcs.	set of 2 pcs.	set of 2 pcs.	set of 2 pcs.	set of 2 pcs.
Order no.	5910 763 000 ^{*8}	5910 755 007	5910 754 000	5910 762 003	5910 758 006	5910 764 006	5910 760 000	5910 757 000	5910 756 003	5910 753 004

^{**} Please perform a manual test to determine the actual loading capacity.

^{*5} Please order adapter for 25 mL conical tubes snap cap 5820 733 004.

^{*6} When used with aerosol-tight caps the max. capacity is reduced to 20 x 50 mL (5 x 50 mL per adapter).

^{*7} Please order adapter for 25 mL conical tubes screw cap 5820 734 000.

^{*8} Coming soon.

Universal Adapters for Rotor S-4xUniversal

Rotor S-4xUniversal brings outstanding versatility to those customers who need to spin a variety of vessels and plates. Three innovative universal adapters accommodate a selection of tubes, plates and bottles:

- > Adapter 1: 5.0 mL and 15 mL conical tubes, MTP/DWP
- > Adapter 2: 25 mL and 50 mL conical tubes, MTP
- > Adapter 3: 25 mL and 50 mL conical tubes, 250 mL bottles, MTP

For customers who need either stacking capability, higher speed or aerosol-tight centrifugation of certain plate formats, a separate plate carrier is available.

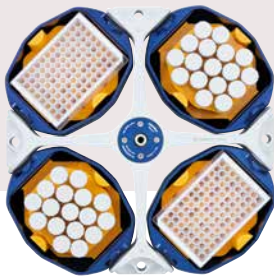

Universal adapter 1

Setup for deepwell plates and Eppendorf Tubes® 5.0 mL.

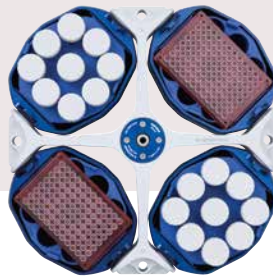

Universal adapter 2

Setup for microplates and 50 mL conical tubes.

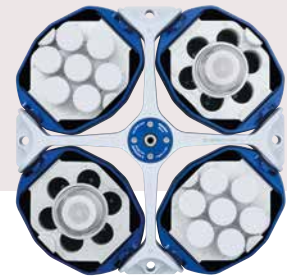

Universal adapter 3

Setup for 50 mL conical tubes and 250 mL bottles.

Eppendorf Tubes® 5.0 mL	15 mL conical	MTP, DWP
17 mm	17 mm	–
124 mm	124 mm	64 mm
122 mm	122 mm	–*2
17/68	1/4	
conical	flat	
191 mm	143 mm	
4,324 × g	3,237 × g	
set of 2 pcs.		
5910 752 008		

25 mL snap cap*5	25 mL screw cap*7	50 mL conical	Microplate 96/384 wells
30 mm	30 mm	30 mm	–
116 mm	116 mm	116*6 mm	16 mm
116*6 mm	116*6 mm	116*6 mm	–
9/36	1/4		
conical	flat		
107 mm	156 mm	192 mm	115 mm
3,758 × g	3,531 × g	4,347 × g	2,604 × g
	set of 2 pcs.		
	5910 769 008		

25 mL snap cap*5	25 mL screw cap*7	50 mL conical	Microplate 96/384 wells	250 mL flat, 175–225 mL conical
30 mm	30 mm	30 mm	–	62 mm
124 mm	124 mm	124 mm	16 mm	146 mm
121 mm	121 mm	121 mm	–	139 mm
7/28	1/4			
conical	flat			
107 mm	155 mm	191 mm	115 mm	187 mm
3,735 × g	3,509 × g	4,324 × g	2,604 × g	4,234 × g
		set of 2 pcs.		
		5910 751 001		



Rotors for Centrifuge 5910 R



Rotor S-4x500

- > Medium capacity swing-bucket rotor with max. speed $3,220 \times g$ (4,000 rpm)
- > Rotor S-4x500 accommodates tubes and bottles from 0.2 mL to 500 mL as well as plates
- > Aerosol-tight caps for safe centrifugation of hazardous samples optionally available*¹
- > Mixed loading with 2 plate buckets and 2 rectangular tube buckets allows for increased versatility
- > Buckets, caps and adapters are autoclavable

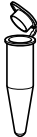
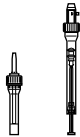
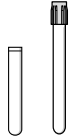
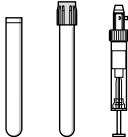
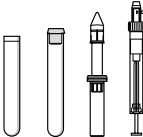
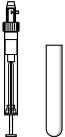
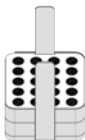
^{**} Aerosol-tightness tested by Public Health England, Porton Down, UK.

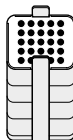
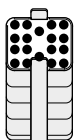
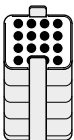
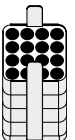
						
Adapters for Rotor S-4x500						
Tube Volume	1.5/2.0 mL	1.2–5 mL	2.6–5 mL	2.6–7 mL	3–15 mL	7–17 mL
Max. tube diameter	11 mm	11 mm	13 mm	13 mm	16 mm	17.5 mm
Max. vessel height	43 mm	108 mm	108 mm	108 mm	108 mm	118 mm
Max. vessel height for use with cap/lid*²	43 mm	108 mm	107 mm	108 mm	108 mm	118 mm
Adapter						
Number of vessels per adapter/rotor	20/80	20/80	25/100	18/72	16/64	16/64
Bottom shape	flat	flat	flat with rubber mat	flat with rubber mat	flat with rubber mat	flat with rubber mat
Centrifugation radius	165 mm	168 mm	168 mm	168 mm	168 mm	168 mm
Max. RCF	$2,950 \times g$	$3,000 \times g$	$3,000 \times g$	$3,000 \times g$	$3,000 \times g$	$3,000 \times g$
Packing	set of 2 pcs.	set of 2 pcs.	set of 2 pcs.	set of 2 pcs.	set of 2 pcs.	set of 2 pcs.
Order no.	5810 745 004	5810 746 000	5810 720 001	5810 747 007	5810 748 003	5810 721 008

^{**} Please perform a manual test to determine the actual loading capacity.
^{**} Please order adapter for 50 mL conical tubes skirted 5804 737 008.



Ordering information

Description	Order no.
Rotor S-4x500 , for 500 mL rectangular buckets or MTP/Flex buckets incl. 4 x 500 mL rectangular buckets	5895 170 005
without buckets	5895 171 001
Lid , aerosol-tight, for 500 mL rectangular bucket, set of 2 pcs.	5810 724 007
MTP/Flex bucket , for Rotor A-4-81 and Rotor S-4x500, set of 2 pcs.	5810 742 005
MTP/Flex bucket , for Rotor A-4-81 and Rotor S-4x500, set of 4 pcs.	5810 741 009

Eppendorf Tubes® 5.0 mL and 15 mL conical tubes	25 mL snap cap	25 mL screw cap	50 mL conical	30–50 mL and 50 mL conical tubes, skirted*3	180–250 mL flat/ 175–225 mL conical	400 mL	500 mL	MTP, DWP, PCR plates
17.5 mm	39 mm	29.8 mm	30 mm	30 mm	62 mm	80 mm	83 mm	–
121 mm	83 mm	78.5 mm	122 mm	121 mm	133 mm	133 mm	134 mm	60 mm
121 mm	83 mm	78.5 mm	116 mm	–	–	–	134 mm	–
12/48	5/20	5/20	5/20	5/20	1/4	1/4	–/4	4/16 (MTP) 1/4 (DWP)
conical	conical	conical	conical	flat with rubber mat	flat with rubber mat	flat, rubber	flat	flat with rubber mat
173 mm	158 mm	148 mm	173 mm	173 mm	173 mm	180 mm	180 mm	163 mm
3,100 × g	2,826 × g	2,647 × g	3,100 × g	3,100 × g	3,100 × g	3,220 × g	3,220 × g	2,900 × g
set of 2 pcs.	set of 2 pcs.	set of 2 pcs.	set of 2 pcs.	set of 2 pcs.	set of 2 pcs.	set of 2 pcs.	–	set of 2 pcs.
5810 722 004	5810 723 000	5810 723 000	5810 723 000	5810 739. 004	5825 722 000	5810 728 002	–	5810 742 005

Rotors for Centrifuge 5910 R



Rotor S-4x400

- > High-speed medium capacity swing-bucket rotor with max. speed $5,263 \times g$ (5,100 rpm)
- > Broad range of adapters enables high versatility for tubes and bottles from 0.2 mL to 400 mL
- > Aerosol-tight QuickLock caps for safe centrifugation of hazardous samples optionally available*¹
- > Buckets, caps and adapters are autoclavable

*¹ Aerosol-tightness tested by Public Health England, Porton Down, UK.

Ordering information

Description

Rotor S-4x400, incl. 400 mL round bucket

Aerosol-tight caps, for Rotor S-4x400, set of 2 pcs.

Order no.

5895 180 000

5910 700 008

Adapters for Rotor S-4x400

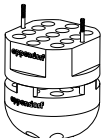
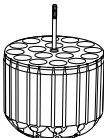
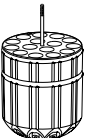
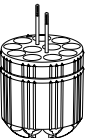
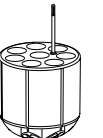
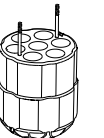









Tube Volume	1.5 mL/2.0 mL	12 mm × 75 mm	4–8 mL	7.5–10 mL	9 mL	Eppendorf Tubes® 5.0 mL and 15 mL conical
Max. tube diameter	11 mm	12 mm	13 mm	16 mm	17.5 mm	17 mm
Max. vessel height	39 mm	188 mm	119 mm	122 mm	122 mm	133 mm
Max. vessel height for use with cap/lid* ²	–	112 mm	105 mm	115 mm	115 mm	126 mm
Adapter						
Number of vessels per adapter/rotor	26/104	17/68	15/60	11/44	8/32	7/28
Bottom shape	open	round	round	round	round	conical
Centrifugation radius	177 mm	172 mm	171 mm	173 mm	173 mm	180 mm
Max. RCF	$5,147 \times g$	$5,002 \times g$	$4,818 \times g$	$4,874 \times g$	$4,874 \times g$	$5,071 \times g$
Packing	set of 2 pcs.	set of 2 pcs.	set of 2 pcs.	set of 2 pcs.	set of 2 pcs.	set of 2 pcs.
Order no.	5910 708 009	5910 711 000	5910 703 007	5910 704 003	5910 709 005	5910 702 000

*² Please perform a manual test to determine the actual loading capacity.

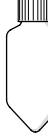
*³ Please order adapter for 25 mL conical tubes snap cap 5820 733 004.

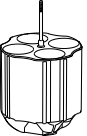
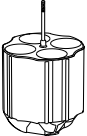
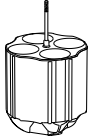
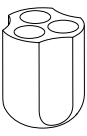
*⁴ Please order adapter for 25 mL conical tubes screw cap 5820 734 000.



						
25 mL snap cap* ³	25 mL screw cap* ⁴	50 mL conical	50 mL skirted, Centriprep® and Oak Ridge 30 mL	175 mL conical (Becton Dickinson®, Nalgene®), 250 mL flat	175–225 mL conical	400 mL
30 mm	30 mm	30 mm	29 mm	62 mm	62 mm	81 mm
83 mm	78.5 mm	125 mm	122 mm	138 mm	143 mm	117 mm
83 mm	78.5 mm	117 mm	121 mm	129 mm	137 mm	117 mm
						
4/16	4/16	4/16	3/12	1/4	1/4	1/4
conical	conical	conical	conical	flat	conical	flat
152 mm	142 mm	179 mm	170 mm	174 mm	181 mm	173 mm
4,420 × g	4,129 × g	5,043 × g	4,943 × g	5,060 × g	5,263 × g	5,030 × g
set of 2 pcs.	set of 2 pcs.	set of 2 pcs.	set of 2 pcs.	set of 2 pcs.	set of 2 pcs.	set of 2 pcs.
5910 701 004	5910 701 004	5910 701 004	5910 712 006	5910 705 000	5910 714 009	5910 706 006

Rotors for Centrifuge 5910 R and Centrifuge 5920 R







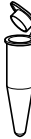

Rotor S-4x750

- > Medium capacity swing-bucket rotor with max. speed $4,800 \times g$ (4,700 rpm)*¹
- > Broad range of adapters enables high versatility for tubes and flasks from 0.2 mL to 750 mL and plates
- > Mixed loading with 2 plate buckets and 2 round tube buckets allows for increased versatility
- > Aerosol-tight QuickLock caps for safe centrifugation of hazardous samples optionally available*²
- > Buckets, caps and adapters are autoclavable

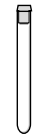
*¹ Aerosol-tightness tested by Public Health England, Porton Down, UK.

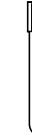
*² For 100 V device, max. speed $4,031 \times g$ / 4,300 rpm

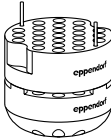
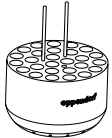
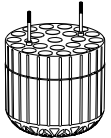
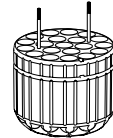
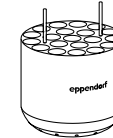
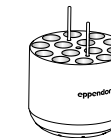
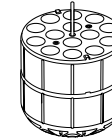
							
Adapters for Rotor S-4x750							
Tube Volume	1.5/2.0 mL	12 x 75 mm, 5 mL FACS	2.6–8 mL	5.5–12 mL	9 mL	14 mL	Eppendorf Tubes® 5.0 mL and 15 mL conical
Max. tube diameter	11 mm	12 mm	13 mm	16 mm	17.5 mm	17.5 mm	17 mm
Max. vessel height	39 mm	120 mm	121 mm	125 mm	117 mm	106 mm	125 mm
Max. vessel height for use with cap/lid*³	39 mm	113 mm	113 mm	120 mm	112 mm	106 mm	120 mm
Adapter							
Number of vessels per adapter/rotor	50/200	27/108	23/92	20/80	20/80	14/56	14/56
Bottom shape	flat	round	round	round	round	round	conical
Centrifugation radius	194 mm	186 mm	185 mm	186 mm	185 mm	185 mm	188 mm
Max. RCF	$4,800 \times g$	$4,593 \times g$	$4,569 \times g$	$4,594 \times g$	$4,569 \times g$	$4,569 \times g$	$4,643 \times g$
Packing	set of 2 pcs.	set of 2 pcs.	set of 2 pcs.	set of 2 pcs.	set of 2 pcs.	set of 2 pcs.	set of 2 pcs.
Order no.	5825 740 009	5825 747 003	5825 738 004	5825 736 001	5825 743 008	5825 748 000	5825 734 009

*³ Exceeding the maximum tube length may reduce the loading capacity of the rotor. Please perform a manual swing-out test before starting the centrifuge run to make sure the tubes do not hit the rotor yoke.

*⁴ Please order adapter for 25 mL conical tubes snap cap 5820 733 004.















*⁵ Please order adapter for 25 mL conical tubes screw cap 5820 734 000.

*⁶ Please note that these conical bottles need to be used together with a conical form insert provided by the manufacturer.

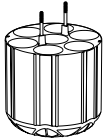
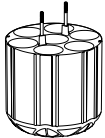
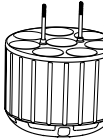
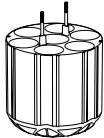
*⁷ 225 mL conical bottles from Becton Dickinson®/Corning® and Nunc 250 mL conical bottles for Rotor S-4-104.

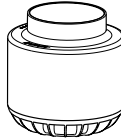
Ordering information

Description	Order no.
Rotor S-4x750 , aerosol-tight, without buckets	5895 121 004
Rotor S-4x750 , aerosol-tight, incl. 4 × 750 mL round buckets	5895 120 008
Plate bucket (aerosol-tight capable) , incl. plate carrier , for Rotor S-4x750, set of 2 pcs.	5895 125 000
Round buckets , for Rotor S-4x750, set of 2 pcs.	5895 123 007
Round buckets , for Rotor S-4x750, set of 4 pcs.	5895 122 000
Plate bucket (aerosol-tight capable) , incl. plate carrier , for Rotor S-4x750, set of 4 pcs.	5895 124 003
Caps for plate buckets (aerosol-tight capable) , aerosol-tight, for Rotor S-4-104 and Rotor S-4x750, set of 2 pcs.	5820 748 001
Caps for 750 mL round buckets , aerosol-tight, for Rotor S-4-104, Rotor S-4x750 and Rotor S-4x1000, set of 2 pcs.	5820 747 005
Wide-neck bottle 750 mL , for Rotor S-4-104, S-4x750, S-4x1000, set of 2 pcs.	5820 708 000

								
25 mL snap cap*4	25 mL screw cap*5	30 mL	50 mL conical	50 mL conical, skirted	250 mL flat, 17–225/250 mL conical*6,7	500 mL Corning®	750 mL	MTP, DWP, PCR plates
30 mm	30 mm	25 mm	30 mm	30 mm	62 mm	96 mm	102 mm	–
83 mm	78.5 mm	119 mm	122 mm	122 mm	145 mm	147 mm	150 mm	64 mm
83 mm	78.5 mm	114 mm	116 mm	116 mm	125 mm	–	150 mm	47 mm
								
6/24	7/28	8/32	7/28	5/20	1/4	1/4	1/4	4/16 (MTP) 1/4 (DWP)
conical	conical	flat	conical	conical	flat	conical	flat	–
167 mm	157 mm	181 mm	187 mm	177 mm	183 mm	186 mm	185 mm	161 mm
4,124 × g	3,877 × g	4,470 × g	4,618 × g	4,371 × g	4,519 × g	4,594 × g	4,569 × g	3,976 × g
set of 2 pcs.	set of 2 pcs.	set of 2 pcs.	set of 2 pcs.	set of 2 pcs.	set of 2 pcs.	set of 2 pcs.	set of 2 pcs.	set of 2 pcs.
5825 733 002	5825 733 002	5825 755 006	5825 733 002	5825 732 006	5825 741 005	5825 745 000	5825 744 004	5895 125 000

Rotors for Centrifuge 5920 R



Rotor S-4xUniversal-Large

- > Extra high capacity swing-bucket rotor with max. speed $4,402 \times g$ (4,250 rpm)
- > Broad range of adapters enables high versatility for tubes and flasks from 0.2 mL to 750 mL and plates
- > Universal bucket design accommodates both plates and tubes
- > Aerosol-tight Eppendorf QuickLock® caps for safe centrifugation of hazardous samples optionally available*¹
- > Buckets, caps and adapters are autoclavable



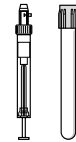
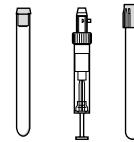
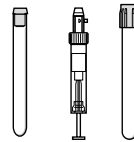

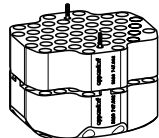
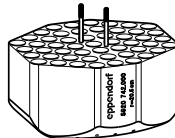
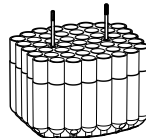
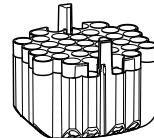
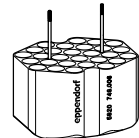

*¹ Aerosol-tightness tested by Public Health England, Porton Down, UK.



Adapters for Rotor S-4xUniversal-Large

Tube Volume	1.5/2.0 mL	5 mL FACS	2.6–8 mL	5.5–12 mL	9 mL
Max. tube diameter	11 mm	12 mm	13 mm	16 mm	17.5 mm
Max. vessel height	39 mm	113 mm	110 mm	110 mm	136 mm
Max. vessel height for use with cap/lid	39 mm	82 mm	107 mm	106 mm	130 mm
Adapter					
Number of vessels per adapter/rotor	92/368	51/204	49/196	37/148	28/112
Bottom shape	flat	round	round	round	round
Centrifugation radius	205 mm	205 mm	205 mm	204 mm	209 mm
Max. RCF	$4,140 \times g$	$4,140 \times g$	$4,140 \times g$	$4,120 \times g$	$4,221 \times g$
Packing	set of 2 pcs.	set of 2 pcs.	set of 2 pcs.	set of 2 pcs.	set of 2 pcs.
Order no.	5920 747 002	5920 742 000	5920 739 000	5920 738 003	5920 746 006

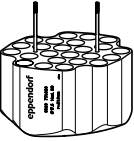
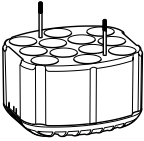
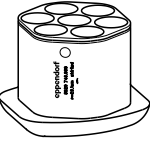
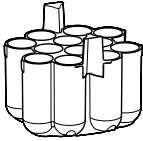
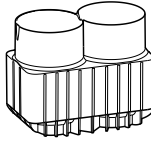
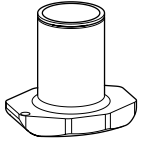

					
14 mL	30 mL	50 mL conical, skirted	50 mL Nalgene® Oak Ridge	250 mL flat, 175–225 mL conical	250 mL conical (Corning®, Nunc)
17.5 mm	25 mm	30 mm	29 mm	62 mm	62 mm
123 mm	117 mm	141 mm	132 mm	133 mm	171 mm
120 mm	108 mm	121 mm	121 mm	126 mm	144 mm
					
24/96	12/48	7/28	12/48	2/8	1/4
round	flat	conical	round	flat	flat
210 mm	194 mm	197 mm	206 mm	203 mm	208 mm
4,240 × g	3,918 × g	3,978 × g	4,160 × g	4,099 × g	4,200 × g
set of 2 pcs.	set of 2 pcs.	set of 2 pcs.	set of 2 pcs.	set of 2 pcs.	set of 2 pcs.
5920 751 000	5920 743 007	5920 748 009	5920 753 002	5920 740 008	5920 750 003

Rotors for Centrifuge 5920 R



Ordering information

Description

Rotor S-4xUniversal-Large, incl. buckets



Aerosol-tight caps, for Rotor S-4xUniversal-Large, set of 2 pcs.

Order no.

5895 190 006

5920 752 006

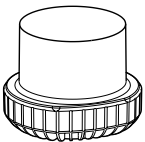
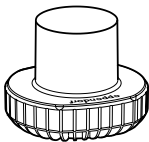
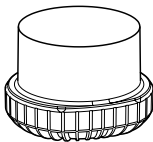
Adapters for Rotor S-4xUniversal-Large

Tube Volume	500 mL conical Corning®	500 mL flat Nalgene®	750 mL	Micro Fluidic Cards	MTP, DWP, PCR plates
Max. tube diameter	96 mm	69.5 mm	102 mm	n/a	n/a
Max. vessel height	160 mm	168 mm	166 mm	153 mm	116 mm
Max. vessel height for use with cap/lid	148 mm	143 mm	143 mm	–	110 mm
Adapter					
Number of vessels per adapter/rotor	1/4	1/4	1/4	3/12	5/20 (MTP) 2/8 (DWP)
Bottom shape	conical	flat	flat	flat	flat
Centrifugation radius	208 mm	206 mm	202 mm	200 mm	196 mm
Max. RCF	4,200 × g	4,160 × g	4,079 × g	4,039 × g	3,938 × g
Packing	set of 2 pcs.	set of 2 pcs.	set of 2 pcs.	set of 2 pcs.	set of 2 pcs.
Order no.	5920 744 003	5920 745 000	5920 741 004	5920 749 005	5920 737 007

** Coming soon.

Universal Adapters for Rotor S-4xUniversal-Large

New universal adapters for rotor S-4xUniversal-Large accommodate bottles, plates and conical tubes. No need to change rotor or rotor buckets.

- > Adapter 1: 5.0 mL and 15 mL conical tubes, MTP/DWP
- > Adapter 2: 25 mL and 50 mL conical tubes, MTP
- > Adapter 3: 25 mL and 50 mL conical tubes, 250 mL bottles, MTP





Eppendorf Tubes® 5.0 mL	15 mL conical	MTP, DWP	25 mL snap cap	25 mL screw cap	50 mL conical	Microplate 96/384 wells	25 mL snap cap	25 mL screw cap	50 mL conical	Microplate 96/384 wells	250 mL flat, 175–225 mL conical
17 mm	17 mm	–	30 mm	30 mm	30 mm	–	30 mm	30 mm	30 mm	–	62 mm
131 mm	131 mm	45 mm	131 mm	131 mm	131 mm	45 mm	131 mm	131 mm	131 mm	18 mm	133 mm
123 mm	123 mm	45 mm	125 mm	125 mm	125 mm	45 mm	125 mm	125 mm	125 mm	–	126 mm
		2 MTP 1 DWP				2 MTP 1 DWP					
conical	skirted		conical		skirted		conical		skirted	flat	
218 mm	160 mm		189 mm	179 mm	213 mm	153 mm	107 mm	155 mm	213 mm	134 mm	207 mm
4,402 × g	3,231 × g		3,816 × g	3,614 × g	4,301 × g	3,090 × g	3,735 × g	3,509 × g	4,301 × g	2,706 × g	4,180 × g
set of 2 pcs.			set of 2 pcs.				set of 2 pcs.				
5920 757 008*1			5920 756 001*1				5920 755 005*1				

Rotors for Centrifuge 5920 R

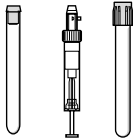
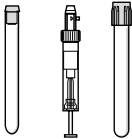

Rotor S-4x1000 with high-capacity buckets

- > Extra high capacity swing-bucket rotor with max. speed $3,153 \times g$ (3,700 rpm)
- > Bucket accommodates both plates and tubes
- > Buckets, caps and adapters are autoclavable

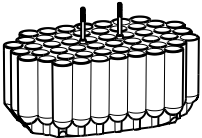
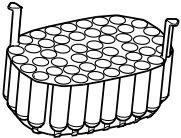
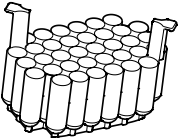
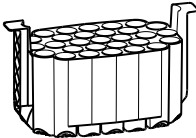
				
Adapters for Rotor S-4x1000 high-capacity buckets				
Tube Volume	5 mL FACS	2.6–8 mL	5.5–12 mL	9 mL
Max. tube diameter	12 mm	13 mm	16 mm	17.5 mm
Max. vessel height	108 mm	107 mm	107 mm	129 mm
Adapter				
Number of vessels per adapter/rotor	52/208	49/196	36/144	29/116
Bottom shape	round	round	round	round
Centrifugation radius	204 mm	204 mm	199 mm	204 mm
Max. RCF	$3,122 \times g$	$3,122 \times g$	$3,046 \times g$	$3,122 \times g$
Packing	set of 2 pcs.	set of 2 pcs.	set of 2 pcs.	set of 2 pcs.
Order no.	5920 724 002	5920 718 002	5920 720 007	5920 722 000

*1 Please order adapter for 25 mL conical tubes snap cap 5820 733 004.

*2 Please order adapter for 25 mL conical tubes screw cap 5820 734 000.



Ordering information

Description	Order no.
Rotor S-4x1000 , without buckets	5895 101 003
High-capacity bucket , for Rotor S-4x1000, set of 4 pcs.	5895 106 005
Plate carrier for high-capacity bucket , for Rotor S-4x1000, for high-capacity buckets, set of 2 pcs.	5920 729 004

Eppendorf Tubes® 5.0 mL and 15 mL conical	25 mL snap cap*1	25 mL screw cap*2	50 mL conical	250 mL flat, 175–225 mL conical and Nunc 250 mL conical	MTP, DWP, PCR plates
17 mm	30 mm	30 mm	30 mm	62 mm	–
121 mm	83 mm	78.5 mm	116 mm	148 mm	88 mm
27/108	13/52	13/52	13/52	2/8	6/24 (MTP) 2/8 (DWP)
conical	conical	conical	conical	flat	flat
205 mm	179 mm	169 mm	206 mm	200 mm	185 mm
3,138 × g	2,739 × g	2,586 × g	3,153 × g	3,061 × g	2,832 × g
set of 2 pcs.	set of 2 pcs.	set of 2 pcs.	set of 2 pcs.	set of 2 pcs.	set of 2 pcs.
5920 716 000	5920 715 003	5920 715 003	5920 715 003	5920 717 006	5920 729 004

Rotors for Centrifuge 5920 R





Rotor S-4x1000 with plate/tube buckets

- > High capacity swing-bucket rotor with max. speed $3,076 \times g$ (3,700 rpm)
- > Bucket accommodates both plates and tubes
- > Aerosol-tight QuickLock caps for safe centrifugation of hazardous samples optionally available*¹
- > Buckets, caps and adapters are autoclavable

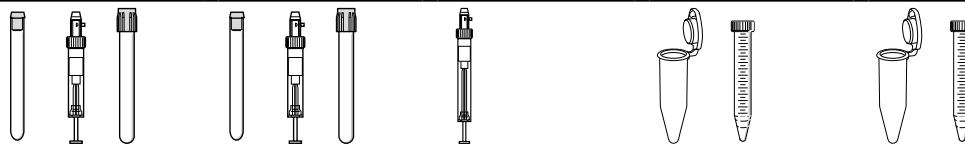
*¹ Aerosol-tightness tested by Public Health England, Porton Down, UK.

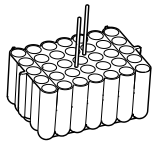
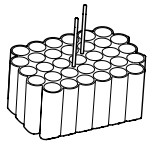
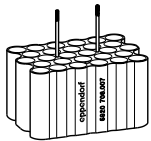

Adapters for Rotor S-4x1000 plate/tube buckets

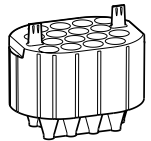
Tube Volume	2.6–8 mL	5.5–12 mL	9 mL	Eppendorf Tubes® 5.0 mL and 15 mL conical	Eppendorf Tubes® 5.0 mL and 15 mL conical
Max. tube diameter	13 mm	16 mm	17.5 mm	17 mm	17 mm
Max. vessel height	109 mm	109 mm	109 mm	121 mm	123 mm
Max. vessel height for use with cap/lid* ²	108* ² mm	108 mm	109 mm	–	121 mm
Adapter					
Number of vessels per adapter/rotor	35/140	33/132	28/112	22/88	16/64
Bottom shape	round	round	round	conical	conical
Centrifugation radius	201 mm	200 mm	200 mm	201 mm	201 mm
Max. RCF	$3,076 \times g$	$3,061 \times g$	$3,061 \times g$	$3,076 \times g$	$3,076 \times g$
Packing	set of 2 pcs.	set of 2 pcs.	set of 2 pcs.	set of 2 pcs.	set of 2 pcs.
Order no.	5920 706 004	5920 707 000	5920 708 007	5920 710 001	5920 712 004

*² Please perform a manual test to determine the actual loading capacity.

*³ Please order adapter for 25 mL conical tubes snap cap 5820 733 004.

*⁴ Please order adapter for 25 mL conical tubes screw cap 5820 734 000.



Ordering information

Description	Order no.
Rotor S-4x1000 , without buckets	5895 101 003
Aerosol-tight caps , for S-4x1000 plate/tube bucket and S-4x750 plate bucket, set of 2 pcs.	5895 111 009
Plate/tube bucket , for Rotor S-4x1000, set of 4 pcs.	5895 104 002
Plate carrier for plate/tube bucket , for Rotor S-4x1000 with plate/tube buckets, Rotor S-4x1000, set of 2 pcs.	5920 705 008
Plate/tube bucket , for Rotor S-4x1000, set of 2 pcs.	5895 105 009

25 mL snap cap* ³	25 mL snap cap* ³	25 mL screw cap* ⁴	25 mL screw cap* ⁴	50 mL conical	50 mL conical	MTP, DWP, PCR plates
30 mm	30 mm	30 mm	30 mm	30 mm	30 mm	n/a
83 mm	83 mm	78.5 mm	78.5 mm	121 mm	121 mm	104 mm
-	83 mm	-	78.5 mm		121 mm	91 mm
9/36	6/24	10/40	7/28	10/40	7/28	10/40(MTP) 2/8(DWP)
conical	conical	conical	conical	conical	conical	flat
175 mm	107 mm	165 mm	166 mm	201 mm	201 mm	198 mm
2,678 x g	2,693 x g	2,525 x g	2,540 x g	3,076 x g	3,076 x g	3,030 x g
set of 2 pcs.	set of 2 pcs.	set of 2 pcs.	set of 2 pcs.	set of 2 pcs.	set of 2 pcs.	set of 2 pcs.
5920 709 003	5920 711 008	5920 709 003	5920 711 008	5920 709 003	5920 711 008	5920 705 008

Rotors for Centrifuge 5920 R





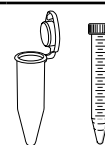
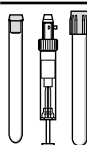
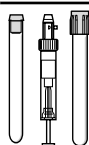

Rotor S-4x1000 with round buckets

- > Medium capacity swing-bucket rotor with max. speed $3,428 \times g$ (3,700 rpm)
- > Broad range of adapters enables high versatility for tubes and flasks from 0.2 mL to 1,000 mL and plates
- > Mixed loading with 2 plate buckets and 2 round tube buckets allows for increased versatility
- > Aerosol-tight QuickLock caps for safe centrifugation of hazardous samples optionally available*¹
- > Buckets, caps and adapters are autoclavable

*¹ Aerosol-tightness tested by Public Health England, Porton Down, UK.

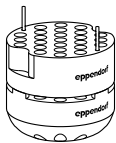
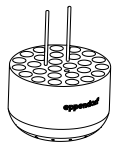

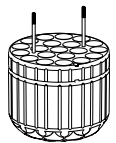
Adapters for Rotor S-4x1000 round buckets

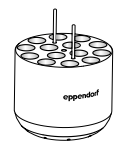
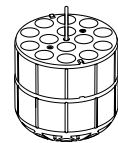
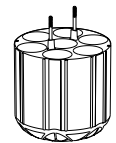
Tube Volume	1.5/2.0 mL	12 x 75 mm, 5 mL FACS	2.6-8 mL	5.5-12 mL	9 mL	14 mL	Eppendorf Tubes® 5.0 mL and 15 mL conical	25 mL snap cap* ³
Max. tube diameter	11 mm	12 mm	13 mm	16 mm	17.5 mm	17.5 mm	17 mm	30 mm
Max. vessel height	39 mm	115 mm	121 mm	140 mm	117 mm	117 mm	161 mm	83 mm
Max. vessel height for use with cap/lid* ²	39 mm	108 mm	113 mm	140 mm	112 mm	112 mm	150 mm	83 mm
Adapter								
Number of vessels per adapter/rotor	50/200	27/108	23/92	20/80	20/80	14/56	14/56	6/24
Bottom shape	flat	round	round	round	round	round	conical	conical
Centrifugation radius	219 mm	211 mm	210 mm	211 mm	210 mm	210 mm	224 mm	107 mm
Max. RCF	$3,352 \times g$	$3,229 \times g$	$3,214 \times g$	$3,229 \times g$	$3,214 \times g$	$3,214 \times g$	$3,428 \times g$	$2,005 \times g$
Packing	set of 2 pcs.	set of 2 pcs.	set of 2 pcs.	set of 2 pcs.	set of 2 pcs.	set of 2 pcs.	set of 2 pcs.	set of 2 pcs.
Order no.	5825 740 009	5825 747 003	5825 738 004	5825 736 001	5825 743 008	5825 748 000	5825 734 009	5825 733 002

*² Exceeding the maximum tube length may reduce the loading capacity of the rotor. Please perform a manual swing-out test before starting the centrifuge run to make sure the tubes do not hit the rotor yoke.

*³ Please order adapter for 25 mL conical tubes snap cap 5820 733 004.















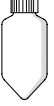

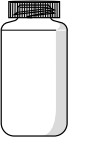
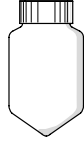

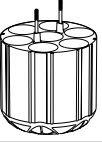
*⁴ Please order adapter for 25 mL conical tubes screw cap 5820 734 000.

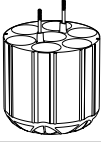
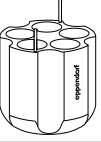
*⁵ Please note that these conical bottles need to be used together with a conical form insert provided by the manufacturer.

*⁶ 225 mL conical bottles from Becton Dickinson®/Corning® and Nunc 250 mL conical bottles for Rotor S-4-104.

Ordering information

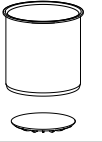
Description	Order no.
Rotor S-4x1000 , without buckets	5895 101 003
Round bucket , for Rotor S-4x1000, set of 4 pcs.	5895 102 000
Rotor S-4x1000 round buckets , aerosol-tight, incl. 4 × 1,000 mL round buckets	5895 100 007
Aerosol-tight caps , for S-4x1000 plate/tube bucket and S-4x750 plate bucket, set of 2 pcs.	5895 111 009
Plate/tube bucket , for Rotor S-4x1000, set of 4 pcs.	5895 104 002
Plate carrier for plate/tube bucket , for Rotor S-4x1000 with plate/tube buckets, Rotor S-4x1000, set of 2 pcs.	5920 705 008
Plate/tube bucket , for Rotor S-4x1000, set of 2 pcs.	5895 105 009
Caps for 750 mL round buckets , aerosol-tight, for Rotor S-4-104, Rotor S-4x750 and Rotor S-4x1000, set of 2 pcs.	5820 747 005

										
25 mL screw cap*4	30 mL	50 mL conical	50 mL conical, skirted	250 mL flat, 175–225/250 mL conical*5,6	500 mL Corning®	500 mL Nalgene®	600 mL TPP	750 mL	1 Liter Nalgene®	MTP, DWP, PCR plates
30 mm	25 mm	30 mm	30 mm	62 mm	96 mm	69.5 mm	98 mm	102 mm	98 mm	n/a
78.5 mm	144 mm	156 mm	156 mm	176 mm	167 mm	183 mm	181 mm	150 mm	196 mm	104 mm
78.5 mm	139 mm	150 mm	147 mm	156 mm	167 mm	183 mm	181 mm	150 mm	–	91 mm
										
7/28	8/32	7/28	5/20	1/4	1/4	1/4	1/4	1/4	1/4	7/28 (MTP) 2/8 (DWP)
conical	flat	conical	conical	flat	conical	flat	conical	flat	flat	flat
121 mm	212 mm	223 mm	209 mm	214 mm	218 mm	221 mm	224 mm	216 mm	218 mm	198 mm
1,852 × g	3,245 × g	3,413 × g	3,199 × g	3,275 × g	3,336 × g	3,382 × g	3,428 × g	3,306 × g	3,336 × g	3,030 × g
set of 2 pcs.	set of 2 pcs.	set of 2 pcs.	set of 2 pcs.	set of 2 pcs.	set of 2 pcs.	set of 2 pcs.	set of 2 pcs.	set of 2 pcs.	set of 2 pcs.	set of 2 pcs.
5825 733 002	5825 755 006	5825 733 002	5825 732 006	5825 741 005	5825 745 000	5920 703 005	5920 701 002	5825 744 004	5920 700 006	5895 105 009

Rotors for 5910 R/5920 R



Rotor FA-6x250

- > Fixed-angle rotor for up to 6 x 250 mL bottles*¹
- > Ideal for the pelleting of microorganisms and mammalian cells
- > 12 different adapters for broad range of additional applications
- > Max. speed 15,054 × *g* (10,100 rpm)
- > Eppendorf QuickLock® rotor lid for fast lid locking
- > Aerosol-tight*² for safe centrifugation of hazardous samples
- > Low weight of only 5,450 g for stress-free work
- > Anodized aluminum for high chemical resistance
- > Rotor, lid and adapters are autoclavable to reduce risk of contamination
- > See tab 'Additional information' for overview of adapters available

*¹ To run this rotor, a software update is required for earlier centrifuges. Please contact your local Eppendorf organization or dealer for further information.
*² Aerosol-tightness tested by Public Health England, Porton Down, UK. Maximum 80% of maximum filling volume.



Ordering information

Description

Rotor FA-6x250, for 6 x 250 mL bottles incl. aerosol-tight Eppendorf QuickLock® rotor lid

Order no.

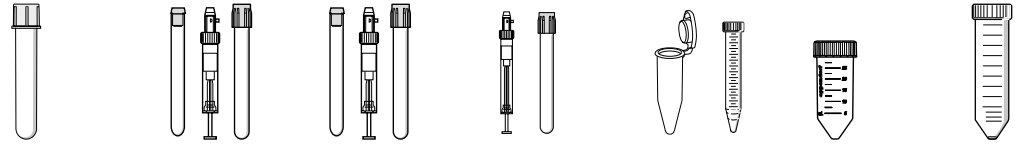
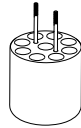
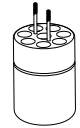
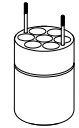
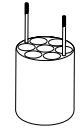
5895 175 007

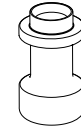
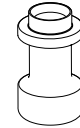
							
Adapters for Rotor FA-6x50	5 mL	2.6–8 mL	5.5–12 mL	9 mL	Eppendorf Tubes® 5.0 mL* ⁴ and 15 mL	25 mL screw cap* ⁵	50 mL
Tube Volume	5 mL	2.6–8 mL	5.5–12 mL	9 mL	Eppendorf Tubes® 5.0 mL* ⁴ and 15 mL	25 mL screw cap* ⁵	50 mL
Max. tube diameter	12 mm	13 mm	16 mm	17.5 mm	17 mm	30 mm	30 mm
Max. vessel height for use with cap/lid*³	114 mm	114 mm	115 mm	112 mm	122 mm	78.5 mm	125 mm
Adapter							
Number of vessels per adapter/rotor	9/54	8/48	7/42	7/42	4/24	1/6	1/6
Bottom shape	round	round	round	round	conical	conical	conical
Centrifugation radius	126 mm	125 mm	125 mm	126 mm	120 mm	95 mm	110 mm
Max. RCF	14,370 × <i>g</i>	14,256 × <i>g</i>	14,256 × <i>g</i>	14,370 × <i>g</i>	13,686 × <i>g</i>	10,834 × <i>g</i>	12,545 × <i>g</i>
Packing	set of 2 pcs.	set of 2 pcs.	set of 2 pcs.	set of 2 pcs.	set of 2 pcs.	set of 2 pcs.	set of 2 pcs.
Order no.	5920 765 000	5920 763 008	5920 762 001	5920 764 004	5920 761 005	5920 760 009	5920 760 009

*³ Please perform a manual test to determine the actual loading capacity.

*⁴ Universal adapters for Eppendorf Tubes® 5.0 mL are required in addition (order no. 5820 732 008).

*⁵ Please order adapter for 25 mL conical tubes screw cap 5820 734 000.

*⁶ 175 mL conical bottles from Becton Dickinson®/Corning® (352076). Please note that these conical tubes bottles need to be used together with a conical form insert provided by the bottle manufacturer.

*⁷ 250 mL flat bottom bottles from Nalgene® (3127-0250, 3122-0250, 3120-0250) and Corning® (431841, 431842).

When used with wide lid 250 mL flat bottom bottle from Nalgene® (3140-0250) max. capacity is reduced to 4 x 250 mL.



50 mL	10 mL	16 mL	30 mL	50 mL	85 mL	175 mL*6	250 mL*7
30 mm	17 mm	18 mm	26 mm	29 mm	38 mm	62 mm	62 mm
125 mm	115 mm	115 mm	116 mm	125 mm	118 mm	118 mm	135 mm
						—	—
1/6	7/42	7/42	3/18	1/6	1/6	1/6	1/6
conical, skirted	round	round	round	round	round	conical	flat
108 mm	126 mm	126 mm	125 mm	111 mm	113 mm	132 mm	132 mm
12,317 × g	14,370 × g	14,370 × g	14,256 × g	12,659 × g	12,887 × g	15,054 × g	15,054 × g
set of 2 pcs.	set of 2 pcs.	set of 2 pcs.	set of 2 pcs.	set of 2 pcs.	set of 2 pcs.	—	—
5920 766 007	5920 769 006	5920 770 004	5920 767 003	5920 771 000	5920 768 000	Conical form insert required*6	No adapter required*7

Rotors for Centrifuge 5910 R and Centrifuge 5920 R



Rotor FA-6x50

- > High-speed rotor for applications in tubes from 5–50 mL
- > Max. speed $20,133 \times g$ (12,100 rpm)
- > Eppendorf QuickLock® rotor lid for fast lid locking
- > Aerosol-tight*¹ for safe centrifugation of hazardous samples
- > Low rotor weight (3,200 g) for easy handling
- > Anodized aluminum for high chemical resistance
- > 45° borehole angle minimizes pellets smear
- > Rotor, lid and adapters are autoclavable

*¹ Aerosol-tightness tested by Public Health England, Porton Down, UK.

Ordering information

Description	Order no.
Rotor FA-6x50, aerosol-tight, incl. rotor lid	5895 150 004

Adapters for Rotor FA-6x50						
Tube Volume	2.6–5 mL	4–8 mL	5.5–10 mL	7.5–12 mL	Eppendorf Tubes® 5.0 mL	7–17 mL
Max. tube diameter	13 mm	13 mm	16 mm	16 mm	17 mm	17.5 mm
Max. vessel height for use with cap/lid	119 mm	119 mm	119 mm	119 mm	121 mm	112 mm
Adapter						
Number of vessels per adapter/rotor	1/6	1/6	1/6	1/6	1/6* ²	1/6
Bottom shape	round	round	round	round	conical	round
Centrifugation radius	120 mm	120 mm	120 mm	120 mm	121 mm	120 mm
Max. RCF	$19,642 \times g$	$19,642 \times g$	$19,642 \times g$	$19,642 \times g$	$19,806 \times g$	$19,642 \times g$
Packing	set of 2 pcs.	set of 2 pcs.	set of 2 pcs.	set of 2 pcs.	set of 2 pcs.	set of 2 pcs.
Order no.	5820 726 008	5820 725 001	5820 728 000	5820 727 004	5820 730 005	5820 729 007

*² Eppendorf Tubes® 5.0 mL with screw cap will not fit in this adapter.















Eppendorf Conical Tubes



Whether centrifugation, mixing, or other applications – the Eppendorf Conical Tubes 15 mL, 25 mL and 50 mL will perfectly fit into your workflows. They represent the next step in Eppendorf’s comprehensive system solutions in liquid, sample and cell handling.

More information:
www.eppendorf.com/conicals



						
15 mL	15–18 mL	20–30 mL	25 mL snap cap	25 mL screw cap	35 mL	50 mL conical
17 mm	18 mm	26 mm	30 mm	30 mm	29 mm	30 mm
125 mm	107 mm	104 mm	83 mm	78.5 mm	113 mm	127 mm
						
1/6	1/6	1/6	1/6	1/6	1/6	-/6
conical	round	round	conical	conical	conical	conical
120 mm	120 mm	105 mm	104 mm	97 mm	112 mm	123 mm
19,642 × g	19,642 × g	17,187 × g	17,023 × g	15,877 × g	18,333 × g	20,130 × g
set of 2 pcs.	set of 2 pcs.	set of 2 pcs.	set of 2 pcs.	set of 2 pcs.	set of 2 pcs.	-
5820 717 009	5820 720 000	5820 721 006	5820 733 004	5820 734 000	5820 722 002	-

Rotors for Centrifuge 5910 R and Centrifuge 5920 R



Rotor FA-20x5

- > 20 places for Eppendorf Tubes® 5.0 mL*¹
- > Max. speed: 20,913 × *g* (13,100 rpm)
- > Aerosol-tight Eppendorf QuickLock® rotor lid*²
- > Rotor, lid and adapters are autoclavable (121 °C, 20 min)
- > Anodized aluminum for high chemical resistance

*¹ For Eppendorf Tubes® 5.0 mL with screw cap the capacity is limited to 10 tubes.

*² Aerosol-tightness tested by Public Health England, Porton Down, UK.

Ordering information

Description	Order no.
Rotor FA-20x5 , for 20 Eppendorf Tubes® 5.0 mL, incl. aerosol-tight Eppendorf QuickLock® rotor lid	5895 130 003
Adapter , for 1 PCR tube 0.2 mL, max. Ø 6 mm, for all 1.5/2.0 mL rotors, set of 6 pcs.	5425 715 005
Adapter , for 1 tube 0.5 mL or BD Microtainer®, max. Ø 8 mm, for all 1.5/2.0 mL rotors, set of 6 pcs.	5425 716 001
Adapter , for 1 vessel 1.5–2.0 mL, for all 5.0 mL rotors, set of 4 pcs.	5820 768 002
Adapter , for 1 cryo tube, for all 5.0 mL rotors, set of 4 pcs.	5820 769 009
Adapter , for 1 HPLC tube, for all 5.0 mL rotors, set of 4 pcs.	5820 770 007
Adapter , for 1 tube 0.4 mL, max. Ø 6 mm, for all 1.5/2.0 mL rotors, set of 6 pcs.	5425 717 008



Rotor FA-48x2

- > 48 places for 1.5/2.0 mL tubes
- > Max. speed: 21,194 × *g*/13,700 rpm (5920 R)/
22,132 × *g*/14,000 rpm (5910 R)
- > Eppendorf QuickLock® rotor lid for fast lid locking
- > Aerosol-tight for safe centrifugation of hazardous samples*³
- > Anodized aluminum for high chemical resistance
- > Rotor and lid are autoclavable (121 °C, 20 min)

*³ Aerosol-tightness tested by Public Health England, Porton Down, UK.

Ordering information

Description	Order no.
Rotor FA-48x2 , incl. aerosol-tight Eppendorf QuickLock® rotor lid	5895 135 005

Rotors for Centrifuge 5910 R



Rotor F-48x15

- > High-capacity fixed-angle rotor for 15 mL conical and glass tubes
- > Max. speed: $5,005 \times g$ (5,500 rpm)
- > Form inserts for 15 mL conical tubes

Ordering information

Description

Rotor F-48x15, for 40 x 15 mL conical tubes, incl. 48 steel sleeves and adapters

Order no.

5895 160 000



Rotor FA-30x2

- > 30 places for 1.5/2.0 mL tubes
- > Max. speed: $20,984 \times g$ (max. 13,700 rpm)
- > Eppendorf QuickLock® rotor lid for fast lid locking
- > Aerosol-tight for safe centrifugation of hazardous samples*¹
- > Anodized aluminum for high chemical resistance
- > Rotor and lid are autoclavable (121 °C, 20 min)

*¹ Aerosol-tightness tested by Public Health England, Porton Down, UK.

Ordering information

Description

Rotor FA-30x2, incl. aerosol-tight Eppendorf QuickLock® rotor lid

Order no.

5895 155 006



We have been developing and producing well sophisticated, groundbreaking products and solutions in the areas of Liquid Handling, Cell Handling and Sample Handling for more than 70 years. We always had one goal in mind: to make your job in the lab easier and more efficient.

To find out more about the Eppendorf product world, visit www.eppendorf.com

Liquid Handling



In 1961, Eppendorf launched the first piston-stroke pipette. Today, our broad product offerings in Liquid Handling range from manual pipettes to electronic pipettes, dispensers and burettes to automated pipetting systems. Eppendorf products are associated with state-of-the-art technology, outstanding ergonomics and award-winning design. This applies to both devices and the requisite consumables such as pipette tips and Combitips®.



■ Multipipette® E3/E3x

A motor driven dispensing system that utilizes the positive displacement principle and is capable of accurately pipetting any liquid.

- > Eliminates time consuming volume calculations with auto Combitip recognition
- > One-button tip ejector for one handed operation and contact-free advanced ejection



■ Combitips advanced®

Combitips advanced have been completely redesigned and optimized to meet all the needs of any modern laboratory.

- > The 9 volume sizes (0.1 mL – 50 mL) offer a maximum range of dispensing volumes
- > High-precision dispensing regardless of the physical properties of the liquid



■ epMotion® 96 /96xl

The epMotion 96 and 96xl are semi-automated electronic pipettes for fast and precise parallel 96 channel microplate processing.

- > Without changes to the system, a large volume range of 0.5 to 300 µL (epMotion 96) or 5 - 1000 µL (epMotion 96xl) is available
- > Performs 12 times faster than 8 channel pipettes



■ Eppendorf Xplorer®/Xplorer® plus

The Eppendorf Xplorer electronic pipettes are designed to eliminate many of potential error risks associated with manual pipetting.

- > Single, 8-, and 12-channel pipettes for liquid volumes from 0.5 µL to 10 mL
- > Intuitive operating concept for quick and easy work



■ Easypet® 3

Experience a new dimension of electronic pipetting with complete speed control and the utmost precision.

- > Intuitive and convenient speed adjustment simply done with the tips of your fingers
- > Lightweight, well-balanced and ergonomic design that allows for fatigue-free pipetting





Packages Centrifuge 5910 R

Ordering information

Description	Max. capacity per rotor	Order no.
Centrifuge 5910 R , refrigerated, with Rotor S-4xUniversal, 230 V/50–60 Hz, incl. universal buckets and adapters for 5 mL/15 mL/50 mL conical tubes and plates* ¹	68 × 15 mL/36 × 50 mL	*2
Centrifuge 5910 R , refrigerated, with Rotor S-4xUniversal, 230 V/50–60 Hz, incl. universal buckets and adapters for 5 mL/15 mL/50 mL conical tubes, 175 mL–250 mL bottles and plates	68 × 15 mL/28 × 50 mL	*2
Centrifuge 5910 R , refrigerated, with Rotor S-4xUniversal, 230 V/50–60 Hz, incl. universal buckets and adapters for round-bottom tubes with diameter 13/16 mm	120 × 13 mm/104 × 16 mm	*2
Centrifuge 5910 R , refrigerated, with Rotor S-4x750, 230 V/50–60 Hz, incl. round buckets and adapters for 5 mL/15 mL/50 mL conical tubes	56 × 15 mL/28 × 50 mL	*2
Centrifuge 5910 R , refrigerated, with Rotor S-4x500, 230 V/50–60 Hz, incl. rectangular buckets and adapters for 15 mL/50 mL conical tubes	48 × 15 mL/20 × 50 mL	*2

*¹ When used with aerosol-tight caps the max. capacity is reduced to 20 × 50 mL (5 × 50 mL per bucket)

*² For ordering information, please check our local website or contact your local sales representative.
www.eppendorf.com/centrifugation



Packages Centrifuge 5920 R

Ordering information

Description	Max. capacity per rotor	Order no.
Centrifuge 5920 R , refrigerated, with Rotor S-4xUniversal-Large, 230 V/50–60 Hz, incl. universal buckets and adapters for 5 mL/15 mL/25 mL/50 mL conical tubes and plates	96 × 15 mL/40 × 50 mL	*3
Centrifuge 5920 R , refrigerated, with Rotor S-4xUniversal-Large, 230 V/50–60 Hz, incl. universal buckets and adapters for round-bottom tubes with diameter 13/16 mm	196 × 13 mm/148 × 16 mm	*3
Centrifuge 5920 R , refrigerated, with Rotor S-4x1000, 230 V/50–60 Hz, incl. high-capacity buckets and adapters for 15 mL/50 mL conical tubes	108 × 15 mL/52 × 50 mL	*3
Centrifuge 5920 R , refrigerated, with Rotor S-4x1000, 230 V/50–60 Hz, incl. plate/tube buckets and adapters for 15 mL/50 mL conical tubes	88 × 15 mL/40 × 50 mL	*3
Centrifuge 5920 R , refrigerated, with Rotor S-4x1000, 230 V/50–60 Hz, incl. round buckets and adapters for 15 mL/50 mL conical tubes	56 × 15 mL/28 × 50 mL	*3

*³ For ordering information, please check our local website or contact your local sales representative.
www.eppendorf.com/centrifugation



Eppendorf Centrifuge 5910 R and Centrifuge 5920 R

Technical specifications

Model	Centrifuge 5910 R	Centrifuge 5920 R
Max. RCF		
> with fixed-angle rotor	22,132 × <i>g</i>	21,194 × <i>g</i>
> with swing-bucket rotor	5,263 × <i>g</i>	4,791 × <i>g</i>
Speed	100–14,000 rpm	100–13,700 rpm
Max. capacity	4 × 1,000 mL/4 × 5 MTP/36 × 50 mL tubes	4 × 1,000 mL/4 × 7 MTP/52 × 50 mL tubes
Acceleration/braking ramps	10/10	10/10
Number of programs	99 (5 program keys)	99 (5 program keys)
Timer	10 s to 99 h 59 min, with continuous run function, short-spin	10 s to 99 h 59 min, with continuous run function, short-spin
Cooling	refrigerated	refrigerated
Temperature control range	–11 °C to 40 °C	–11 °C to 40 °C
Noise level		
Rotor FA-6x50	<59 dB(A)	<60 dB(A)
Rotor S-4x750	<57 dB(A)	–
Rotor S-4xUniversal	<53 dB(A)	–
Rotor S-4xUniversal-Large	–	<55 dB(A)
Power supply	230 V, 50–60 Hz	230 V, 50–60 Hz
Max. power consumption	1,650 W	1,650 W
Dimensions (W × D × H)	72 × 66 × 37 cm	74 × 71 × 40 cm
Footprint (dimensions w/o front panel, WxD)	72 × 62 cm	74 × 67 cm
Height (with open lid)	85 cm	94 cm
Weight w/o accessories	109 kg	139 kg

Technical specifications are subject to change. Errors and omissions excepted.

Ordering information

Description	Order no.
Centrifuge 5910 R, refrigerated, 230 V/50–60 Hz	*1
Centrifuge 5920 R, refrigerated, 230 V/50–60 Hz	*2

*1 For ordering information, please check our local website or contact your local sales representative.

www.eppendorf.com/centrifugation



*2 For ordering information, please check our local website or contact your local sales representative.

www.eppendorf.com/centrifugation



Your local distributor: www.eppendorf.com/contact
 Eppendorf AG · Barkhausenweg 1 · 22339 Hamburg · Germany
eppendorf@eppendorf.com · www.eppendorf.com

www.eppendorf.com/centrifugation